



V826764K24SA
64M x 64 HIGH PERFORMANCE
UNBUFFERED DDR SDRAM MODULE

Features

- 184 Pin Unbuffered 67,108,864 x 64 bit Organization DDR SDRAM Modules
- Utilizes High Performance 64M x 8 DDR SDRAM in TSOP11-66 Packages
- Single +2.5V ($\pm 0.2V$) Power Supply
- Single +2.6V ($\pm 0.1V$) Power Supply for DDR400
- Programmable CAS Latency, Burst Length, and Wrap Sequence (Sequential & Interleave)
- Auto Refresh (CBR) and Self Refresh
- All Inputs, Outputs are SSTL-2 Compatible
- 8192 Refresh Cycles every 64 ms
- Serial Presence Detect (SPD)
- DDR SDRAM Performance

Description

The V826764K24SA memory module is organized 67,108,864 x 64 bits in a 184 pin memory module. The 64M x 64 memory module uses 8 ProMOS 64M x 8 DDR SDRAM. The x64 modules are ideal for use in high performance computer systems where increased memory density and fast access times are required.

	Module Speed	D3	C0	Units
	Clock Frequency (max.)	200 (PC400B)	166 (PC333)	MHz
t_{CK}	Clock Cycle Time \overline{CAS} Latency = 3	5	-	ns
	Clock Cycle Time \overline{CAS} Latency = 2.5	6	6	ns
t_{RCD}	tRCD parameter	3	3	CLK
t_{RP}	tRP parameter	3	3	CLK

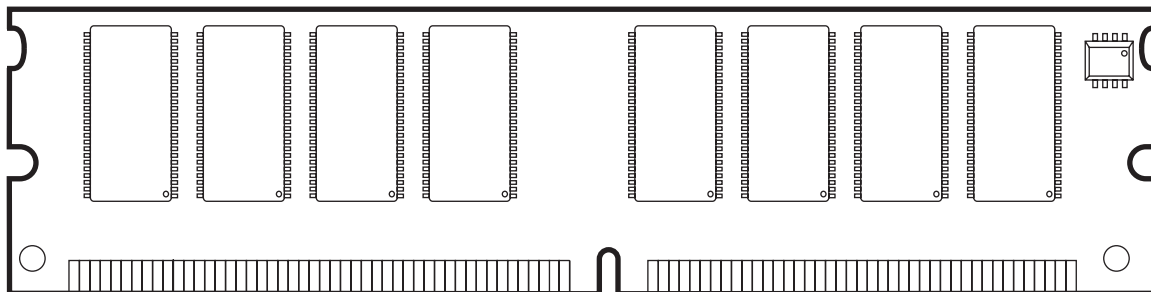

Part Number Information

1	2	3	4	5	6	7	8	9	10	11	12	13	14	15	16	17
V	8	2	6	7	6	4	K	2	4	S	A	I	W	-	C	0

ProMOS	DATA DEPTH 16 : 16Mb 32 : 32 Mb 64 : 64 Mb 65 : 128 Mb 66 : 256 Mb	REFRESH RATE 0: 4K 2: 8K	PCB TYPE G : GOLD_LEAD PLATING W : GOLD_RoHS L : LOW PROFILE_LEAD PLATING X : LOW PROFILE_RoHS																																		
TYPE 8 : DDR	DATA WIDTH & COMP DENSITY 65 X64 using 128M 66 X64 using 256M 67 X64 using 512M 68 X64 using 1G 69 X64 using 2G 73 X72 using 128M 74 X72 using 256M 75 X72 using 512M 76 X72 using 1G 77 X72 using 2G	BANKS 4 : 4 Banks	COMPONENT REV LEVEL																																		
VOLTAGE 2 : 2.5V	MODULE TYPE & COMP WIDTH		COMPONENT PKG																																		
	<table border="1"> <thead> <tr> <th>BASED ON</th> <th>X4</th> <th>X16</th> <th>X8</th> </tr> </thead> <tbody> <tr> <td>184PIN DIMM UNBUFFERED</td> <td>I</td> <td>J</td> <td>K</td> </tr> <tr> <td>184PIN DIMM REGISTERED</td> <td>N</td> <td>O</td> <td>U</td> </tr> <tr> <td>200PIN SO-DIMM</td> <td>V</td> <td>B</td> <td>G</td> </tr> <tr> <td>172PIN Micro-DIMM</td> <td></td> <td></td> <td>M</td> </tr> </tbody> </table>	BASED ON	X4	X16	X8	184PIN DIMM UNBUFFERED	I	J	K	184PIN DIMM REGISTERED	N	O	U	200PIN SO-DIMM	V	B	G	172PIN Micro-DIMM			M	<table border="1"> <thead> <tr> <th>LEAD PLATING</th> <th>GREEN</th> <th>PACKAGE DESCRIPTION</th> </tr> </thead> <tbody> <tr> <td>T</td> <td>I</td> <td>TSOP</td> </tr> <tr> <td>S</td> <td>J</td> <td>FBGA</td> </tr> <tr> <td>D</td> <td>N</td> <td>Die-stacked TSOP</td> </tr> <tr> <td>Z</td> <td>P</td> <td>Die-stacked FBGA</td> </tr> </tbody> </table>	LEAD PLATING	GREEN	PACKAGE DESCRIPTION	T	I	TSOP	S	J	FBGA	D	N	Die-stacked TSOP	Z	P	Die-stacked FBGA
BASED ON	X4	X16	X8																																		
184PIN DIMM UNBUFFERED	I	J	K																																		
184PIN DIMM REGISTERED	N	O	U																																		
200PIN SO-DIMM	V	B	G																																		
172PIN Micro-DIMM			M																																		
LEAD PLATING	GREEN	PACKAGE DESCRIPTION																																			
T	I	TSOP																																			
S	J	FBGA																																			
D	N	Die-stacked TSOP																																			
Z	P	Die-stacked FBGA																																			
			I/O INTERFACE S: SSTL_2																																		
			SPEED B0 : PC2100B (133MHz @CL2.5-3-3) B1 : PC2100A (133MHz @CL2-2-2) C0 : PC2700 (166MHz @CL2.5-3-3) D0 : PC3200 (200MHz @CL2.5-3-3) D3 : PC3200 (200MHz @CL3-3-3)																																		

*RoHS: Restriction of Hazardous Substances
*GREEN: RoHS-compliant and Halogen-Free

Block Diagram

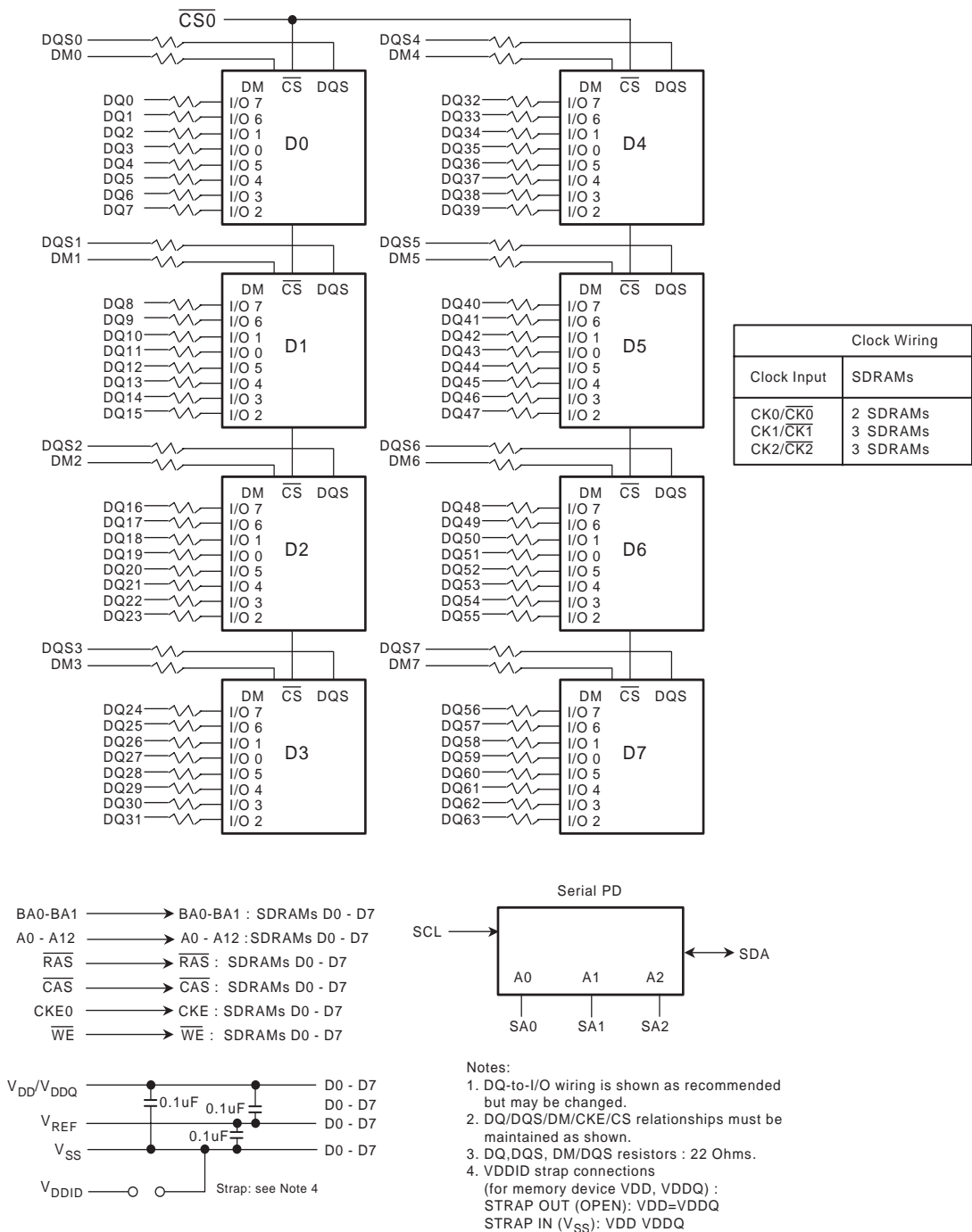

Pin Configurations (Front Side/Back Side)

Pin	Front	Pin	Front	Pin	Front	Pin	Back	Pin	Back	Pin	Back
1	VREF	32	A5	62	VDDQ	93	VSS	124	VSS	154	RAS
2	DQ0	33	DQ24	63	WE	94	DQ4	125	A6	155	DQ45
3	VSS	34	VSS	64	DQ41	95	DQ5	126	DQ28	156	VDDQ
4	DQ1	35	DQ25	65	CAS	96	VDDQ	127	DQ29	157	CS0
5	DQS0	36	DQS3	66	VSS	97	DM0	128	VDDQ	158	CS1
6	DQ2	37	A4	67	DQS5	98	DQ6	129	DM3	159	DM5
7	VDD	38	VDD	68	DQ42	99	DQ7	130	A3	160	VSS
8	DQ3	39	DQ26	69	DQ43	100	VSS	131	DQ30	161	DQ46
9	NC	40	DQ27	70	VDD	101	NC	132	VSS	162	DQ47
10	NC	41	A2	71	NC	102	NC	133	DQ31	163	NC
11	VSS	42	Vss	72	DQ48	103	A13*	134	CB4*	164	VDDQ
12	DQ8	43	A1	73	DQ49	104	VDDQ	135	CB5*	165	DQ52
13	DQ9	44	CB0*	74	VSS	105	DQ12	136	VDDQ	166	DQ53
14	DQS1	45	CB1*	75	CK2	106	DQ13	137	CK0	167	NC
15	VDDQ	46	VDD	76	CK2	107	DM1	138	CK0	168	VDD
16	CK1	47	DQS8*	77	VDDQ	108	VDD	139	VSS	169	DM6
17	CK1	48	A0	78	DQS6	109	DQ14	140	DM8*	170	DQ54
18	VSS	49	CB2*	79	DQ50	110	DQ15	141	A10	171	DQ55
19	DQ10	50	VSS	80	DQ51	111	CKE1	142	CB6*	172	VDDQ
20	DQ11	51	CB3*	81	VSS	112	VDDQ	143	VDDQ	173	NC
21	CKE0	52	BA1	82	VDDID	113	BA2*	144	CB7*	174	DQ60
22	VDDQ	Key		83	DQ56	114	DQ20	Key		175	DQ61
23	DQ16	53	DQ32	84	DQ57	115	A12	145	VSS	176	VSS
24	DQ17	54	VDDQ	85	VDD	116	VSS	146	DQ36	177	DM7
25	DQS2	55	DQ33	86	DQS7	117	DQ21	147	DQ37	178	DQ62
26	VSS	56	DQS4	87	DQ58	118	A11	148	VDD	179	DQ63
27	A9	57	DQ34	88	DQ59	119	DM2	149	DM4	180	VDDQ
28	DQ18	58	VSS	89	VSS	120	VDD	150	DQ38	181	SA0
29	A7	59	BA0	90	NC	121	DQ22	151	DQ39	182	SA1
30	VDDQ	60	DQ35	91	SDA	122	A8	152	VSS	183	SA2
31	DQ19	61	DQ40	92	SCL	123	DQ23	153	DQ44	184	VDDSPD

Notes:

* These pins are not used in this module.

Pin Names

Pin	Pin Description
CK0~ CK2, CK0~ CK2	Differential Clock Inputs
CS0, CS1	Chip Select Input
CKE0, CKE1	Clock Enable Input
RAS, CAS, WE	Command Sets Inputs
A0 ~ A12	Address
BA0, BA1	Bank Address
DQ0~DQ63	Data Inputs/Outputs
DQS0~DQS7	Data Strobe Inputs/Outputs
DM0~DM7	Data-in Mask
VDD	Power Supply

Pin	Pin Description
VDDQ	DQs Power Supply
VSS	Ground
VREF	Reference Power Supply
VDDSPD	Power Supply for SPD
SA0~SA2	E ² PROM Address Inputs
SCL	E ² PROM Clock
SDA	E ² PROM Data I/O
VDDID	VDD Identification Flag
DU	Do not Use
NC	No Connection

Serial Presence Detect Information

Bin Sort:

D3 (PC3200 @ CL 3-3-3)

C0 (PC2700 @ CL 2.5-3-3)

Byte #	Function described	Function Supported		Hex value	
		D3	C0	D3	C0
0	Defines # of Bytes written into serial memory at module manufacturer	128bytes		80h	
1	Total # of Bytes of SPD memory device	256bytes		08h	
2	Fundamental memory type	SDRAM DDR		07h	
3	# of row address on this assembly	13		0Dh	
4	# of column address on this assembly	11		0Bh	
5	# of module Ranks on this assembly	1 Ranks		01h	
6	Data width of this assembly	64 bits		40h	
7Data width of this assembly	-		00h	
8	VDDQ and interface standard of this assembly	SSTL 2.5V		04h	
9	DDR SDRAM cycle time at highest CAS Latency	5ns	6ns	50h	60h
10	DDR SDRAM Access time from clock at highest CL	±0.65ns	±0.70ns	65h	70h
11	DIMM configuration type(Non-parity, Parity, ECC)	Non-parity, Non-ECC		00h	
12	Refresh rate & type	7.8us & Self refresh		82h	
13	Primary DDR SDRAM width	x8		08h	
14	Error checking DDR SDRAM data width	N/A		00h	
15	Minimum clock delay for back-to-back random column address	t _{CCD} =1CLK		01h	
16	DDR SDRAM device attributes : Burst lengths supported	2,4,8		0Eh	
17	DDR SDRAM device attributes : # of banks on each DDR SDRAM	4 banks		04h	
18	DDR SDRAM device attributes : CAS Latency supported	2, 2.5, 3(D3) 2, 2.5(C0)		1Ch	0Ch
19	DDR SDRAM device attributes : CS Latency	0CLK		01h	
20	DDR SDRAM device attributes : WE Latency	1CLK		02h	
21	DDR SDRAM module attributes	Differential clock / non Registered		20h	
22	DDR SDRAM device attributes : General	+/-0.2V voltage tolerance Concurrent Auto Precharge t _{RAS} Lock Out		C0h	
23	DDR SDRAM cycle time at second highest CL	6.0ns	7.5ns	60h	75h
24	DDR SDRAM Access time from clock at second highest CL	±0.70ns	±0.75ns	70h	75h
25	DDR SDRAM cycle time at third highest CL	7.5ns	-	75h	00h
26	DDR SDRAM Access time from clock at third highest CL	±0.75ns	-	75h	00h
27	Minimum row precharge time (=t _{RP})	15ns	18ns	3Ch	48h

Serial Presence Detect Information (cont.)

Byte #	Function described	Function Supported		Hex value	
		D3	C0	D3	C0
28	Minimum row activate to row active delay ($=t_{RRD}$)	10ns	12ns	28h	30h
29	Minimum RAS to CAS delay ($=t_{RCD}$)	15ns	18ns	3Ch	48h
30	Minimum active to precharge time ($=t_{RAS}$)	40ns	42ns	28h	2Ah
31	Module Rank density	512MB		80h	
32	Command and address signal input setup time	0.6ns	0.75ns	60h	75h
33	Command and address signal input hold time	0.6ns	0.75ns	60h	75h
34	Data signal input setup time	0.4ns	0.45ns	40h	45h
35	Data signal input hold time	0.4ns	0.45ns	40h	45h
36-40	Superset information (may be used in future)			00h	
41	SDRAM device minimum active to active/auto-refresh time ($=t_{RC}$)	60ns	60ns	3Ch	3Ch
42	SDRAM device minimum active to autorefresh to active/auto-refresh time ($=t_{RFC}$)	70ns	72ns	46h	48h
43	SDRAM device maximum device cycle time ($=t_{CK MAX}$)	10ns	12ns	28h	30h
44	SDRAM device maximum skew between DQS and DQ signals ($=t_{DQSQ}$)	0.4ns	0.45ns	28h	2Dh
45	SDRAM device maximum read datahold skew factor ($=t_{QHS}$)	0.50ns	0.55ns	50h	55h
46	Superset information (may be used in future)	-		00h	
47	DDR SDRAM DIMM Height	1.125 to 1.25 inches		01h	
48-61	Superset information (may be used in future)	-		00h	
62	SPD data revision code	Initial release 1.0		10h	
63	Checksum for Bytes 0 ~ 62	-		B3h	57h
64	Manufacturer JEDEC ID code	ProMOS		40h	
65 -71 Manufacturer JEDEC ID code			00h	
72	Manufacturing location	02=Taiwan 04=Malaysia 05=China 0A=S-CH			
73-90	Module part number (ASCII)	V826764K24SA D3: DDR400@CL3-3-3 C0: DDR333@CL2.5-3-3			
91	Manufacturer revision code (For PCB)	0		00	
92	Manufacturer revision code (For component)	0		00	
93	Manufacturing date (Year)	-		-	
94	Manufacturing date (Week)	-		-	
95~ 98	Assembly serial #	-		-	
99~ 127	Manufacturer specific data (may be used in future)	Undefined		00h	
128~ 255	Open for customer use	Undefined		00h	

DC Operating Conditions

(T_A = 0 to 70°C, Voltage referenced to V_{SS} = 0V)

Parameter	Symbol	Min	Typ.	Max	Unit	Note
Power Supply Voltage	V _{DD}	2.3	2.5	2.7	V	
Power Supply Voltage for DDR400	V _{DD}	2.5	2.6	2.7	V	
Power Supply Voltage	V _{DDQ}	2.3	2.5	2.7	V	1
Power Supply Voltage for DDR400	V _{DDQ}	2.5	2.6	2.7	V	1
Input High Voltage	V _{IH}	V _{REF} + 0.15	-	V _{DDQ} + 0.3	V	
Input Low Voltage	V _{IL}	-0.3	-	V _{REF} - 0.15	V	2
I/O Termination Voltage	V _{TT}	V _{REF} - 0.04	V _{REF}	V _{REF} + 0.04	V	
Reference Voltage	V _{REF}	V _{DDQ/2} - 0.05	-	V _{DDQ/2} + 0.05	V	
Input Leakage Current	I _I	-2	-	2	μA	
Output Leakage Current	I _{OZ}	-5	-	5	μA	
Output High Current (V _{OUT} = 1.95V)	I _{OH}	-16.8	-	-	mA	
Output Low Current (V _{OUT} = 0.35V)	I _{OL}	16.8	-	-	mA	

- Notes:** 1. V_{DDQ} must not exceed the level of V_{DD}.
 2. V_{IL} (min) is acceptable -1.5V AC pulse width with <= 5ns of duration.

AC Operating Conditions

(T_A = 0 to 70 °C, Voltage referenced to V_{SS} = 0V)

Parameter	Symbol	Min	Max	Unit	Note
Input High (Logic 1) Voltage, DQ, DQS and DM signals	V _{IH(AC)}	V _{REF} + 0.31		V	
Input Low (Logic 0) Voltage, DQ, DQS and DM signals	V _{IL(AC)}		V _{REF} - 0.31	V	
Input Differential Voltage, CK and \overline{CK} inputs	V _{ID(AC)}	0.7	V _{DDQ} + 0.6	V	1
Input Crossing Point Voltage, CK and \overline{CK} inputs	V _{IX(AC)}	0.5*V _{DDQ} -0.2	0.5*V _{DDQ} +0.2	V	2

- Notes:** 1. VID is the magnitude of the difference between the input level on CK and the input on \overline{CK} .
 2. The value of VIX is expected to equal 0.5*V_{DDQ} of the transmitting device and must track variations in the DC level of the same.

AC Operating Test Conditions ($T_A = 0$ to 70°C , Voltage referenced to $V_{SS} = 0\text{V}$)

Parameter	Value	Unit
Reference Voltage	$V_{DDQ} \times 0.5$	V
Termination Voltage	$V_{DDQ} \times 0.5$	V
AC Input High Level Voltage (V_{IH} , min)	$V_{REF} + 0.31$	V
AC Input Low Level Voltage (V_{IL} , max)	$V_{REF} - 0.31$	V
Input Timing Measurement Reference Level Voltage	V_{REF}	V
Output Timing Measurement Reference Level Voltage	V_{TT}	V
Input Signal maximum peak swing	1.5	V
Input minimum Signal Slew Rate	1	V/ns
Termination Resistor (R_T)	50	ohm
Series Resistor (R_S)	25	ohm
Output Load Capacitance for Access Time Measurement (C_L)	30	pF

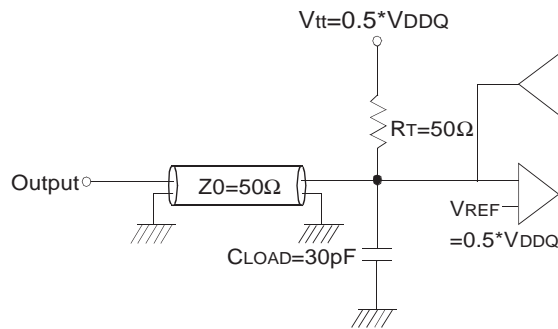

Output Load Circuit (SSTL_2)

Input/Output Capacitance

($V_{DD} = 2.5\text{V}$, $V_{DD} = 2.6\text{V}$, $V_{DDQ} = 2.5\text{V}$, $V_{DDQ} = 2.6\text{V}$, $T_A = 25^\circ\text{C}$, $f = 1\text{MHz}$)

Parameter	Symbol	Min	Max	Unit
Input capacitance ($A_0 \sim A_{11}$, $BA_0 \sim BA_1$, \overline{RAS} , \overline{CAS} , \overline{WE})	C_{IN1}	29	34	pF
Input capacitance (CKE_0)	C_{IN2}	29	34	pF
Input capacitance ($\overline{CS_0}$)	C_{IN3}	26	30	pF
Input capacitance (CLK_1 , CLK_2)	C_{IN4}	30	32	pF
Data & DQS input/output capacitance ($DQ_0 \sim DQ_{63}$)	C_{OUT}	8	9	pF
Input capacitance ($DM_0 \sim DM_8$)	C_{IN5}	8	9	pF

DDR SDRAM Module I_{DD} Spec Table

Symbol		D3 PC3200@CL=3	C0 PC2700A@CL=2.5	Unit
IDD0		1040	960	mA
IDD1		1360	1200	mA
IDD2P		80	80	mA
IDD2F		280	280	mA
IDD2Q		240	240	mA
IDD3P		360	360	mA
IDD3N		480	480	mA
IDD4R		1680	1520	mA
IDD4W		1840	1680	mA
IDD5		2080	1920	mA
IDD6	Normal	40	40	mA
	Low power	20	20	mA
IDD7		2880	2800	mA

* Module I_{DD} was calculated on the basis of component I_{DD} and can be differently measured according to DQ loading cap.

Detailed test conditions for DDR SDRAM IDD1 & IDD

IDD1 : Operating current: One bank operation

1. Typical Case : $V_{dd} = 2.5V$, $T = 25^{\circ}C$
2. Worst Case : $V_{dd} = 2.7V$, $T = 10^{\circ}C$
3. Only one bank is accessed with $t_{RC}(\min)$, Burst Mode, Address and Control inputs on NOP edge are changing once per clock cycle. $I_{out} = 0mA$
4. Timing patterns
 - DDR333 (166MHz, CL=2.5) : $t_{CK} = 6ns$, $CL = 2.5$, $BL = 4$, $t_{RCD} = 3 * t_{CK}$, $t_{RC} = 10 * t_{CK}$, $t_{RAS} = 7 * t_{CK}$
Read : A0 N N R0 N P0 N N N A0 N - repeat the same timing with random address changing *50% of data changing at every burst
 - DDR400B (200MHz, CL=3) : $t_{CK} = 5ns$, $CL = 3$, $BL = 4$, $t_{RCD} = 3 * t_{CK}$, $t_{RC} = 12 * t_{CK}$, $t_{RAS} = 8 * t_{CK}$
Read : A0 N N R0 N P0 N N N A0 N - repeat the same timing with random address changing *50% of data changing at every burst
 - DDR400A (200MHz, CL=2.5) : $t_{CK} = 5ns$, $CL = 2.5$, $BL = 4$, $t_{RCD} = 3 * t_{CK}$, $t_{RC} = 12 * t_{CK}$, $t_{RAS} = 8 * t_{CK}$
Read : A0 N N R0 N P0 N N N A0 N - repeat the same timing with random address changing *50% of data changing at every burst

Legend : A=Activate, R=Read, W=Write, P=Precharge, N=NOP

AC Characteristics (AC operating conditions unless otherwise noted)

Parameter	Symbol	(DDR400B) D3		(DDR333) C0		Unit	Note	
		Min	Max	Min	Max			
Row Cycle Time	t_{RC}	55	-	60	-	ns		
Auto Refresh Row Cycle Time	t_{RFC}	70	-	72	-	ns		
Row Active Time	t_{RAS}	40	70K	42	70K	ns		
Row Address to Column Address Delay	t_{RCD}	15	-	18	-	ns		
Row Active to Row Active Delay	t_{RRD}	10	-	12	-	ns		
Column Address to Column Address Delay	t_{CCD}	1	-	1	-	CLK		
Row Precharge Time	t_{RP}	15	-	18	-	ns		
Write Recovery Time	t_{WR}	15	-	15	-	ns		
Last Data-In to Read Command	t_{DRL}	1	-	1	-	CLK		
Auto Precharge Write Recovery + Precharge Time	t_{DAL}	35	-	35	-	ns		
System Clock Cycle Time	\overline{CAS} Latency = 3	t_{CK}	5	10	-	-	ns	
	\overline{CAS} Latency = 2.5		6	12	6	12	ns	
Clock High Level Width	t_{CH}	0.45	0.55	0.45	0.55	CLK		
Clock Low Level Width	t_{CL}	0.45	0.55	0.45	0.55	CLK		
Data-Out edge to Clock edge Skew	t_{AC}	-0.70	0.70	-0.70	0.70	ns		
DQS-Out edge to Clock edge Skew	t_{DQSCK}	-0.55	0.55	-0.60	0.60	ns		
DQS-Out edge to Data-Out edge Skew	t_{DQSQ}	-	0.40	-	0.45	ns		
Data-Out hold time from DQS	t_{QH}	t_{HPmin} -0.75ns	-	t_{HPmin} -0.75ns	-	ns	1	
Clock Half Period	t_{HP}	$t_{CH/L}$ min	-	$t_{CH/L}$ min	-	ns	1	
Input Setup Time (fast slew rate)	t_{IS}	0.6	-	0.75	-	ns	2,3,5,6	
Input Hold Time (fast slew rate)	t_{IH}	0.6	-	0.75	-	ns	2,3,5,6	
Input Setup Time (slow slew rate)	t_{IS}	0.7	-	0.8	-	ns	2,4,5,6	
Input Hold Time (slow slew rate)	t_{IH}	0.7	-	0.8	-	ns	2,4,5,6	
Input Pulse Width	t_{IPW}	2.2	-	2.2	-	ns	6	
Write DQS High Level Width	t_{DQSH}	0.35		0.35		CLK		
Write DQS Low Level Width	t_{DQSL}	0.35		0.35		CLK		
CLK to First Rising edge of DQS-In	t_{DQSS}	0.72	1.25	0.75	1.25	CLK		
Data-In Setup Time to DQS-In (DQ & DM)	t_{DS}	0.40	-	0.45	-	ns	7	
Data-in Hold Time to DQS-In (DQ & DM)	t_{DH}	0.40	-	0.45	-	ns	7	
DQ & DM Input Pulse Width	t_{DIPW}	1.75	-	1.75	-	ns		

Parameter	Symbol	(DDR400B) D3		(DDR333) C0		Unit	Note
		Min	Max	Min	Max		
Read DQS Preamble Time	t _{RPRE}	0.9	1.1	0.9	1.1	CLK	
Read DQS Postamble Time	t _{RPST}	0.4	0.6	0.4	0.6	CLK	
Write DQS Preamble Setup Time	t _{WPRES}	0	-	0	-	CLK	
Write DQS Preamble Hold Time	t _{WPREH}	0.25	-	0.25	-	CLK	
Write DQS Postamble Time	t _{WPST}	0.4	0.6	0.4	0.6	CLK	
Mode Register Set Delay	t _{MRD}	2	-	2	-	CLK	
Power Down Exit Time to any command	t _{XPDN}	1	-	1	-	CLK	
Exit Self Refresh to Non-Read Command	t _{XSNR}	75	-	75	-	ns	
Exit Self Refresh to Read Command	t _{XSRD}	200	-	200	-	CLK	8
Average Periodic Refresh Interval	t _{REFI}	-	7.8	-	7.8	us	

- Notes:**
1. This calculation accounts for tDQSQ(max), the pulse width distortion of on-chip circuit and jitter.
 2. Data sampled at the rising edges of the clock : A0~A11, BA0~BA1, CKE, CS, RAS, CAS, WE.
 3. For command/address input slew rate >=1.0V/ns
 4. For command/address input slew rate >=0.5V/ns and <1.0V/ns
 5. CK, CK slew rates are >=1.0V/ns
 6. These parameters guarantee device timing, but they are not necessarily tested on each device, and they may be guaranteed by design or tester correlation.
 7. Data latched at both rising and falling edges of Data Strobes(DQS) : DQ, DM
 8. Minimum of 200 cycles of stable input clocks after Self Refresh Exit command, where CKE is held high, is required to complete Self Refresh Exit and lock the internal DLL circuit of DDR SDRAM.

Absolute Maximum Ratings

Parameter	Symbol	Rating	Unit
Ambient Temperature	T _A	0 ~ 70	°C
Storage Temperature	T _{STG}	-55 ~ 125	°C
Voltage on Any Pin relative to V _{SS}	V _{IN} , V _{OUT}	-0.5 ~ 3.6	V
Voltage on V _{DD} relative to V _{SS}	V _{DD}	-0.5 ~ 3.6	V
Voltage on V _{DDQ} relative to V _{SS}	V _{DDQ}	-0.5 ~ 3.6	V
Output Short Circuit Current	I _{OS}	50	mA
Power Dissipation	P _D	12.0	W
Soldering Temperature • Time	T _{SOLDER}	260 • 10	°C • Sec

Note: Operation at above absolute maximum rating can adversely affect device reliability

Package Dimensions

Units: Inches (Millimeters)

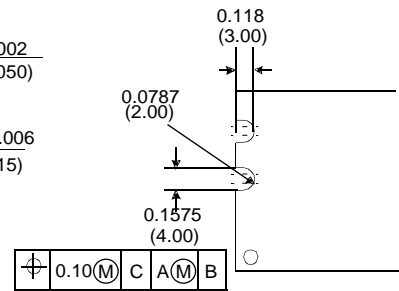
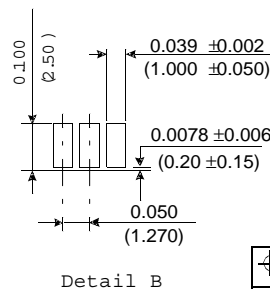
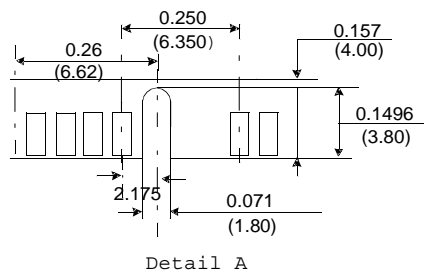
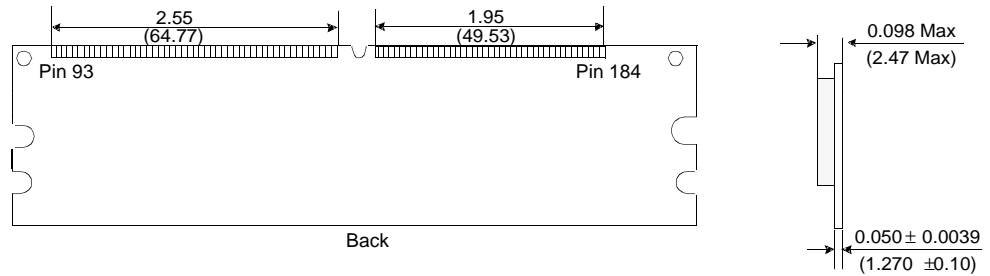
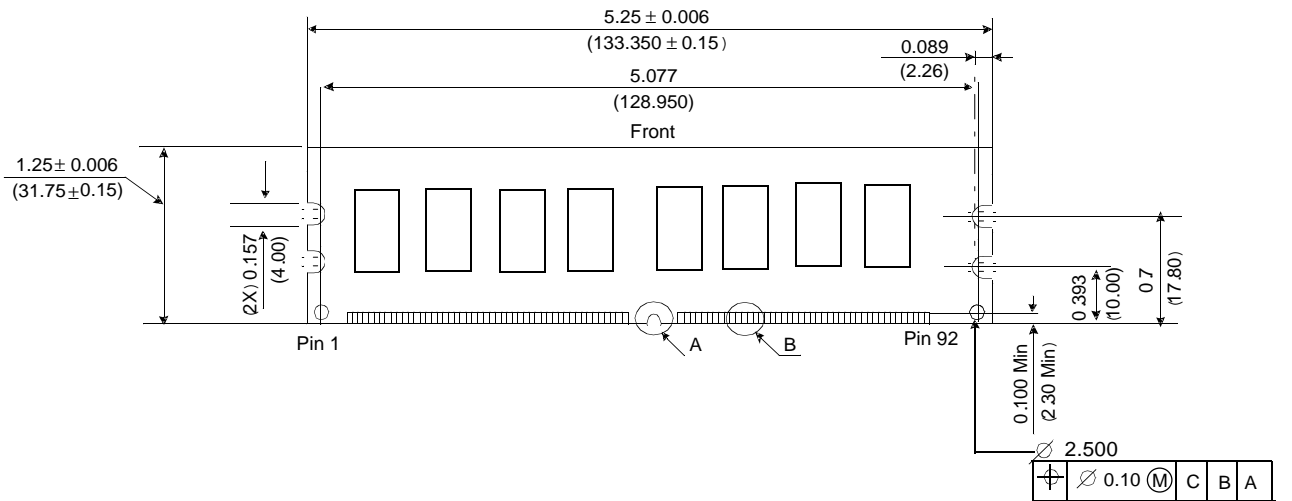

Tolerances : ± 0.005 (.13) unless otherwise specified.

Label Information

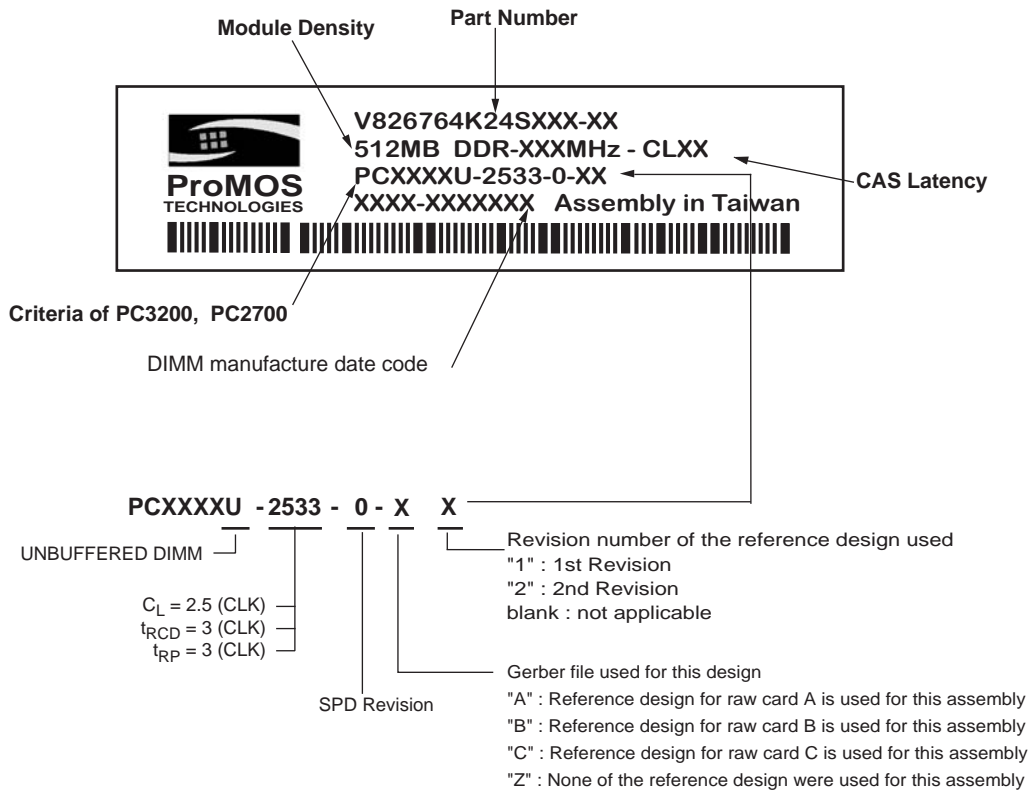

WORLDWIDE OFFICES

SALES OFFICES:

TAIWAN(Hsinchu)

NO. 19 LI HSIN ROAD
SCIENCE BASED IND. PARK
HSIN CHU, TAIWAN, R.O.C.
PHONE: 886-3-566-3952
FAX: 886-3-578-6028

USA(West)

3910 NORTH FIRST STREET
SAN JOSE, CA 95134
PHONE: 408-433-6000
FAX: 408-433-0952

JAPAN

ONZE 1852 BUILDING 6F
2-14-6 SHINTOMI, CHUO-KU
TOKYO 104-0041
PHONE: 81-3-3537-1400
FAX: 81-3-3537-1402

TAIWAN(Taipei)

7F, NO. 102 MIN-CHUAN E. ROAD
SEC. 3, Taipei, Taiwan, R.O.C
PHONE: 886-2-2545-1213
FAX: 886-2-2545-1209

USA(East)

25 Creekside Road
Hopewell Jct, NY 12533
PHONE:845-223-1689
FAX:845-223-1684

The information in this document is subject to change without notice.

ProMOS TECH makes no commitment to update or keep current the information contained in this document. No part of this document may be copied or reproduced in any form or by any means without the prior written consent of ProMOS TECH.

ProMOS TECH subjects its products to normal quality control sampling techniques which are intended to provide an assurance of high quality products suitable for usual commercial applications. ProMOS TECH does not do testing appropriate to provide 100% product quality assurance and does not assume any liability for consequential or incidental arising from any use of its products. If such products are to be used in applications in which personal injury might occur from failure, purchaser must do its own quality assurance testing appropriate to such applications.